



Consumer

# Application Brief



## Smartphone

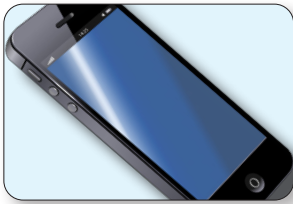

Today's portable communication devices demand increased functionality and longer battery life in smaller ergonomic cases. Central's low  $V_F$  Schottkys, low  $r_{DS(ON)}$  MOSFETs, and low  $V_{CE(SAT)}$  transistors optimally address these requirements with some of the smallest and thinnest energy efficient discrete semiconductors available. Central's standard and ultra-small products solve the most demanding space-constrained application challenges by providing superior electrical and thermal performance.

For more information visit: [www.centrasemi.com/applications](http://www.centrasemi.com/applications)

## Smart Phone Topology

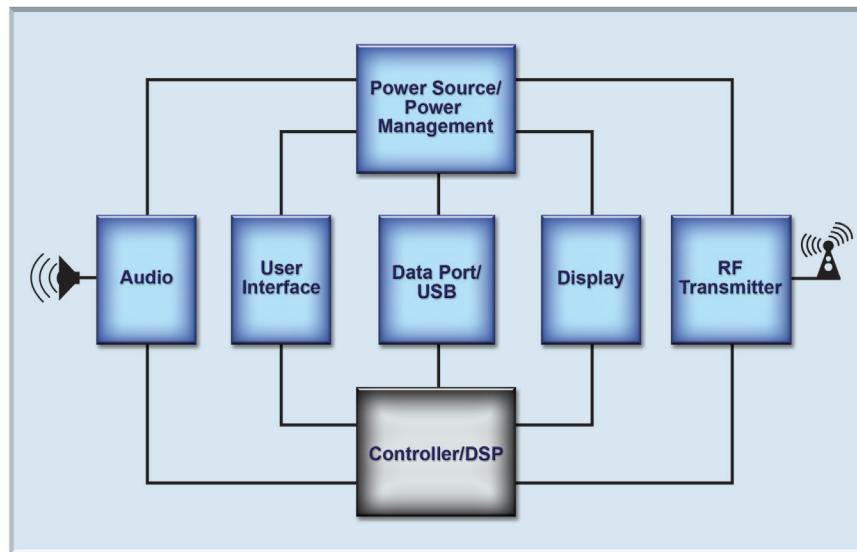

### Power Source/Power Management

#### • Small Signal Transistors

- CMPT491E: 1.0A, 60V NPN (SOT-23)
- CMUT2222A: 600mA, 40V NPN (SOT-523)
- CMUT3410: 1.0A, 25V Low  $V_{CE(SAT)}$  NPN (SOT-523)
- CMUT7410: 1.0A, 25V Low  $V_{CE(SAT)}$  PNP (SOT-523)

#### • Schottky Diodes

- CMLSH05-4: 0.5A, 40V Low  $V_F$  (SOT-563)
- CMLSH1-40: 1.0A, 40V (SOT-563)
- CMSH2-100M: 2.0A, 100V (SMA)
- CMSH2-100M: 2.0A, 100V (SMA)

#### • Schottky Rectifiers

- CMDFSHC3-100: 3.0A, 100V, low profile (SMC DFN)
- CMDFSHC5-100: 5.0A, 100V, low profile (SMC DFN)

#### • MOSFETs

- CMPDM7120G: 1.0A, 20V N-Channel (SOT-23)
- CMLDM7002A: 280mA, 60V Dual, N-Channel (SOT-563)
- CMLDM8002A: 280mA, 50V Dual, P-Channel (SOT-563)
- CEDM7001: 100mA, 20V N-Channel (SOT-883L)
- CEDM8001: 100mA, 20V P-Channel (SOT-883L)
- CMLDM7120G: 1.0A, 20V N-Channel (SOT-563)

#### • Multi Discrete Modules (MDMs)





- CMLM0574: **Combination:** 450mA, 30V N-Channel MOSFET and 0.5A, 40V Schottky Diode (SOT-563)
- CMLM0584: **Combination:** 450mA, 30V P-Channel MOSFET and 0.5A, 40V Schottky Diode (SOT-563)

RF Transmitter, Display, Data Port/USB, User Interface, and Audio continued on reverse side →







## RF Transmitter



### • Small Signal Transistors

-  -CMST2222A: 600mA, 40V NPN (SOT-323)
-  -CMUT2222A: 600mA, 40V NPN (SOT-523)
-  -CMUT3410: 1.0A, 25V Low  $V_{CE(SAT)}$  NPN (SOT-523)
-  -CMUT7410: 1.0A, 25V Low  $V_{CE(SAT)}$  PNP (SOT-523)

### • MOSFETs

-  -CEDM8004: 450mA, 30V P-Channel (SOT-883L)
-  -CMLDM7002A: 280mA, 60V N-Channel Dual (SOT-563)
-  -CMLDM8002A: 280mA, 50V P-Channel Dual (SOT-563)
-  -CMNDM7001: 100mA, 20V N-Channel (SOT-963)
-  -CMNDM8001: 100mA, 20V P-Channel (SOT-963)

### • High Speed Switching Diodes





-  -CMDD2004: 200mA, 240V (SOD-323)
-  -CMLD4448: 250mA, 120V Dual, Isolated (SOT-563)
-  -CMAD4448: 250mA, 120V (SOD-923)

### • Zener Diodes

-  -CMOZ3V3 thru CMOZ15V: 250mW, 3.3V thru 15V (SOD-523)

## Display

### • Schottky Diodes

-  -CMOSH-3: 100mA, 30V (SOD-523)
-  -CTLSH01-30L: 100mA, 30V Low  $V_F$  (TLM2D3D6)
-  -CFSH01-30: 100mA, 30V (SOD-882L)
-  -CMKD4448: 250mA, 100V Triple Isolated (SOT-323)

## Data Port/USB

### • ESD Transient Voltage Suppressor

-  -CSL05D: 400W, 5.0V Dual, Low Capacitance (SOT-23)

### • TVS/Zener Array

-  -CMNTVS12V: 18W, 12V (SOT-953)

## User Interface

### • Uni-polar Transient Voltage Suppressors

-  -CMF5.0A thru CMF12A: 200W, 5.0V thru 12V (SOD-123F)



### • ESD Transient Voltage Suppressor

-  -CSL05D: 400W, 5.0V Dual, Low Capacitance (SOT-23)

### • TVS/Zener Array





-  -CMNTVS12V: 18W, 12V (SOT-953)

### • High Speed Switching Diodes



-  -CMKD4448: 250mA, 100V Triple Isolated (SOT-363)
-  -CMLD4448: 250mA, 120V Dual, Isolated (SOT-563)

## Audio

### • Small Signal Transistors

-  -CMUT3904: 200mA, 40V NPN (SOT-523)
-  -CMUT3906: 200mA, 40V PNP (SOT-523)
-  -CMUT3410: 1.0A, 25V Low  $V_{CE(SAT)}$  NPN (SOT-523)
-  -CMUT7410: 1.0A, 25V Low  $V_{CE(SAT)}$  PNP (SOT-523)

### • Schottky Diodes

-  -CMLSH05-4: 0.5A, 40V Low  $V_F$  (SOT-563)
-  -CMLSH1-40: 1.0A, 40V (SOT-563)

### • High Speed Switching Diode

-  -CMLD4448: 250mA, 120V Dual, Isolated (SOT-563)