



Tablet



The slim profile of tablet devices necessitates semiconductor component packages that are up to 75% thinner than their predecessors, without compromising electrical performance. Concurrently, tablet designers are being asked to improve overall energy efficiency and to protect sensitive integrated circuits from harmful ESD transients. In the face of these design challenges, Central Semiconductor offers a complete solution of low profile and energy efficient discrete components and a full offering of ESD protection products.

For more information visit: www.centalsemi.com/product/tablet

Tablet Topology

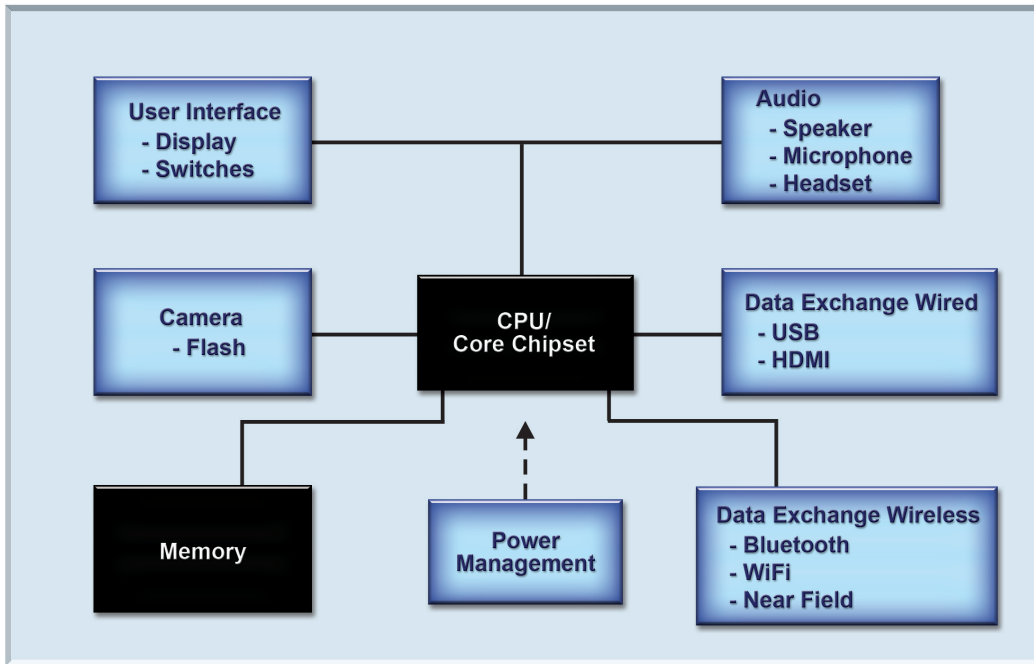

Use QR reader for direct link to application web page.

weblink scan



User Interface

• ESD Transient Voltage Suppressors

- CMATVS5V0: 80W, 5.0V ESD TVS (SOD-923)
- CMOTVS5V7: 66W, 5.7V ESD TVS (SOD-523)
- CMO5V0LC: 12W, 5.0V Low Cap TVS (SOD-523)
- CFTVS5V0LC: 12W, 5.0V Low Cap TVS (SOD-882L)
- CTLTVS12: 35W, 9.0V Low Cap TVS (TLM2D3D6)
- CMATVS3V3: 80W, 3.3V ESD TVS (SOD-923)
- CTLTVS6V2: 35W, 4.0V Low Cap TVS (TLM2D3D6)

• TVS/Zener Array

- CMKTVS5-4: 5.0V 4-line, Low Cap ESD TVS Array (SOT-363)
- CMNTVS5V0: 5.0V 4-line, Low Cap ESD TVS Array (SOT-953)
- CMNTVS12V: 9.0V 4-line, Low Cap ESD TVS Array (SOT-953)

For more information visit: www.centalsemi.com/apps/ui11

Audio

• Small Signal Transistors

- CMUT5088E: 50V, 100mA PNP Low Noise (SOT-523)
- CMUT5087E: 50V, 100mA NPN Low Noise (SOT-523)
- CMPT3904E: 40V, 200mA NPN Low $V_{CE(SAT)}$ (SOT-23)
- CMPT3906E: 40V, 200mA PNP Low $V_{CE(SAT)}$ (SOT-23)
- CET3904E: 40V, 200mA NPN (SOT-883L)
- CET3906E: 40V, 200mA PNP (SOT-883L)

• Schottky Diodes

- CMASH-4: 200mA, 40V (SOD-923)
- CMLSH-4: 200mA, 40V Dual (SOT-563)
- CTLSH01-30L: 100mA, 30V Low V_F (TLM2D3D6)

• ESD Transient Voltage Suppressors

- CFTVS5V0LC: 12W, 5.0V Low Cap TVS (SOD-882L)
- CTLTVS12: 35W, 9.0V Low Cap TVS (TLM2D3D6)

For more information visit: www.centalsemi.com/apps/a11





Consumer

Camera - Flash



• MOSFETs

-  CEDM7001: 20V, 100mA N-Channel (SOT-883L)
-  CEDM8001: 20V, 100mA P-Channel (SOT-883L)
-  CTLDM3590: 20V, 100mA N-Channel (TLM3D6D8)
-  CTLDM7590: 20V, 140mA P-Channel (TLM3D6D8)

• Schottky Diodes

-  CMASH-4: 200mA, 40V (SOD-923)
-  CTLSH01-30L: 100mA, 30V Low V_F (TLM2D3D6)

• Zener Diodes

-  CMOZ12L: 40V, 250mA (SOD-523)
-  CTLZ5V1: 5.1V, 100mW (TLM2D3D6)



For more information visit: www.centrasemi.com/apps/cf11

Data Exchange Wired



• ESD Transient Voltage Suppressors

-  CMATVS5V0: 80W, 5.0V ESD TVS (SOD-923)
-  CMOTVS5V7: 66W, 5.7V ESD TVS (SOD-523)
-  CMO5V0LC: 12W, 5.0V Low Cap TVS (SOD-523)
-  CFTVS5V0LC: 12W, 5.0V Low Cap TVS (SOD-882L)
-  CTLTVS12: 35W, 9.0V Low Cap TVS (TLM2D3D6)

• TVS/Zener Array

-  CMKTVS5-4: 5.0V 4-line, Low Cap ESD TVS Array (SOT-363)
-  CMNTVS5V0: 5.0V 4-line, Low Cap ESD TVS Array (SOT-953)

• Diodes

-  CFD4448: 250mA Low Leakage (SOD-882L)
-  CMAD4448: 250mA Low Leakage (SOD-923)





For more information visit: www.centrasemi.com/apps/dew11

Power Management



• MOSFETs

-  CEDM7001: 20V, 100mA N-Channel (SOT-883L)
-  CEDM8001: 20V, 100mA P-Channel (SOT-883L)
-  CTLDM3590: 20V, 100mA N-Channel (TLM3D6D8)
-  CTLDM7590: 20V, 140mA P-Channel (TLM3D6D8)
-  CMLDM7585: 20V, 650mA Dual N-Channel / P-Channel (SOT-563)



• Schottky Diodes

-  CFSH2-3L: 200mA, Low V_F (SOD-882L)
-  CMLSH05-4: 0.5A, 40V Low V_F (SOT-563)
-  CMLSH1-40: 1.0A, 40V (SOT-563)
-  CTLSH01-30L: 100mA, 30V Low V_F (TLM2D3D6)



• Small Signal Transistors

-  CET3904E: 40V, 200mA NPN (SOT-883L)
-  CET3906E: 40V, 200mA PNP (SOT-883L)



• Multi Discrete Modules

-  CMLM0574: 450mA, 30V N-Channel MOSFET and 0.5A, 40V Schottky Diode (SOT-563)
-  CMLM0584: 450mA, 30V P-Channel MOSFET and 0.5A, 40V Schottky Diode (SOT-563)

• Zener Diodes

-  CMOZ3L3: 3.3V, 250mW (SOD-523)
-  CMOZ5L1: 5.1V, 250mW (SOD-523)
-  CMOZ12L: 40V, 250mW (SOD-523)
-  CTLZ5V1: 5.1V, 100mW (TLM2D3D6)
-  CTLZ6V8: 6.8V, 100mW (TLM2D3D6)



• Uni-polar Transient Voltage Suppressors (TVS)

-  CMF5.0A: 5.0V, 200W (SOD-123F)
-  CMF12A: 12V, 200W (SOD-123F)

For more information visit: www.centrasemi.com/apps/pm11

Data Exchange Wireless



• ESD Transient Voltage Suppressors

-  CMO5V0LC: 12W, 5.0V Low Cap TVS (SOD-523)
-  CFTVS5V0LC: 12W, 5.0V Low Cap TVS (SOD-882L)
-  CTLTVS12: 35W, 9.0V Low Cap TVS (TLM2D3D6)

• TVS/Zener Array

-  CMNTVS5V0: 5.0V 4-line, Low Cap ESD TVS Array (SOT-953)

• Diodes

-  CFD4448: 250mA Low Leakage (SOD-882L)
-  CMAD4448: 250mA Low Leakage (SOD-923)

• Schottky Diodes

-  CTLSH01-30L: 100mA, 30V Low V_F (TLM2D3D6)

For more information visit: www.centrasemi.com/apps/dew11



Innovative Discrete Semiconductors

For further information contact:
Sales at Central Semiconductor Corp.
(631) 435-1110 or visit:
www.centrasemi.com