

## Solar Energy System



Central Semiconductor has developed products well suited for the rigorous high temperature conditions of the solar power industry. Central's devices operate at optimal levels of efficiency while consuming minimal power.

For more information visit: [www.centrasemi.com/product/solar](http://www.centrasemi.com/product/solar)

### Basic Inverter Topology

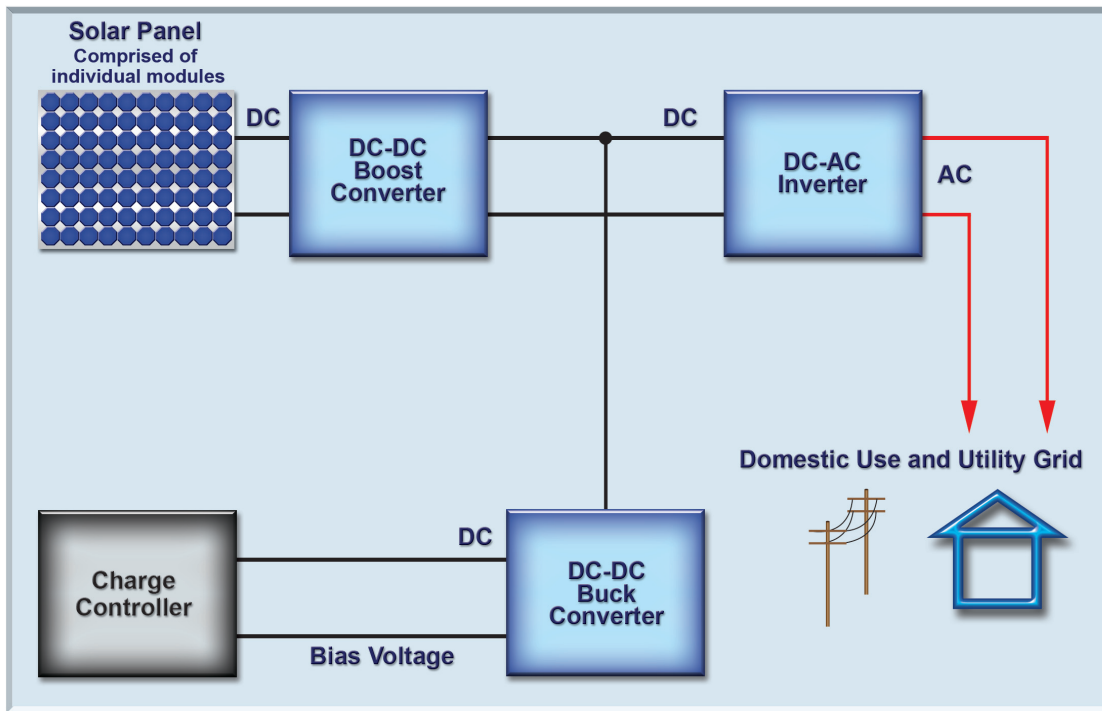

#### DC-DC Boost Converter

- Bi-Directional Transient Voltage Suppressors



- 1SMC5.0CA thru 1SMC170CA (SMC) 1500W, 5V-170V
- 3SMC5.0CA thru 3SMC170CA (SMC) 3000W, 5V-170V

- Ultra Fast Rectifier



- CMR3U-04 (SMC) 3A, 400V

- Schottky Rectifiers



- CMSH3-100 (SMC) 3A, 100V
- CMSH5-100 (SMC) 5A, 100V

For more information visit:  
[www.centrasemi.com/product/solar/dcdc\\_boost\\_converter](http://www.centrasemi.com/product/solar/dcdc_boost_converter)

#### DC-AC Inverter

- Super Fast Rectifiers



- CMR1S-02 (SMB) 1A, 100V
- CMR2S-02 (SMB) 2A, 200V
- CMR2S-04 (SMB) 2A, 400V
- CMR2S-06 (SMB) 2A, 600V



- CMR3S-02 (SMC) 3A, 200V
- CMR3S-06 (SMC) 3A, 600V

- Ultra Fast Rectifier



- CMR1U-04M (SMA) 1A, 400V
- CMR2U-04 (SMB) 2A, 400V
- CMR3U-04 (SMC) 3A, 400V

For more information visit:  
[www.centrasemi.com/product/solar/dcac\\_inverter](http://www.centrasemi.com/product/solar/dcac_inverter)

#### DC-DC Buck Converter

- Schottky Rectifiers



- CMSH3-40 (SMC) 3A, 40V
- CMSH5-40 (SMC) 5A, 40V

- Small Signal MOSFETs



- CMPDM303NH (SOT-23F) 3.6A, 30V N-Channel
- CMPDM302PH (SOT-23F) 2.4A, 30V P-Channel

- Bipolar Power Transistors General Purpose



- CXT3150 (SOT-89) 5A, 50V

For more information visit:  
[www.centrasemi.com/product/solar/dcdc\\_buck\\_converter](http://www.centrasemi.com/product/solar/dcdc_buck_converter)

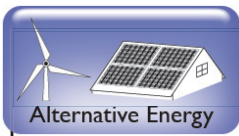

## Solar Panel Bypass Diode

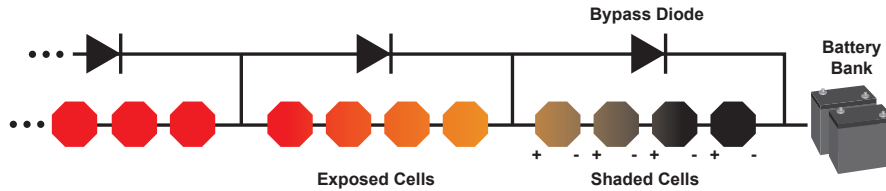



### Function:



Current through a series of solar cells is limited by the resistance, or bias condition, of the “highest resistance” cell. When a cell is shaded, its resistance to the flow of current will increase. The increased resistance of even one cell will limit the overall current that the solar panel can provide to the battery bank. A bypass diode is necessary to avoid this potential inefficiency. Under normal operating conditions, the bypass diode is reversed biased and essentially “invisible” to the overall system.

In order to maximize overall system efficiency, the bypass diode should have the lowest forward voltage ( $V_F$ ) drop possible. Schottky technology provides the most efficient diode for this application; diodes with current ratings of 6 to 16 amps are required.

## Solar Panel Bypass Diode

### • Schottky Rectifier

-  CPD31X (Die) 10A, 60V (optimized for solder process)
-  CPD34X (Die) 10A, 60V (optimized for wire bonding)
-  CPD32X (Die) 10A, 40V (optimized for wire bonding)

-  CSHD6-60C (DPAK) 6A, 60V
-  CSHDD8-60 (D<sup>2</sup>PAK) 8A, 60V
-  CSHD10-100C (DPAK) 10A, 100V



For more information visit: [www.centrasemi.com/product/solar/bypass\\_diode](http://www.centrasemi.com/product/solar/bypass_diode)

## Samples



To order samples of these devices visit:  
<http://web.centrasemi.com/search/sample.php>

## Literature



New  
SMD  
SELECTION  
GUIDE

Order your selection guide today.  
Visit: [web.centrasemi.com/search/sample.php](http://web.centrasemi.com/search/sample.php)



**Innovative Discrete  
Semiconductors**

For further information contact:  
Sales at Central Semiconductor Corp.  
(631) 435-1110 or visit:  
[www.centrasemi.com](http://www.centrasemi.com)